

# bFRIENDS

Des accessoires design et durables permettent un rangement rapide tout en créant une atmosphère inspirante dans tous les environnements. La nouvelle collection d'accessoires bFRIENDS pour l'espace de travail et de vie, conçue en partenariat avec l'équipe de designers de Pearson Lloyd, remplit parfaitement ces exigences. Des matériaux d'emballage en plastique végétal déjà utilisés sont recyclés, transformés en nouveaux filaments et les produits de la collection bFRIENDS sont créés à partir de là

en utilisant un procédé d'impression 3D. La gamme comprend de nombreux produits tels que pots, plateaux et boîtes pour ranger vos ustensiles, des supports polyvalents, des articles décoratifs, des vases et bacs à plantes ainsi que des crochets et clips flexibles. Les accessoires bFRIENDS sont disponibles en différentes tailles et se distinguent par leur multifonctionnalité. Leurs possibilités d'utilisation sont infinies.

**Design: Pearson Lloyd**

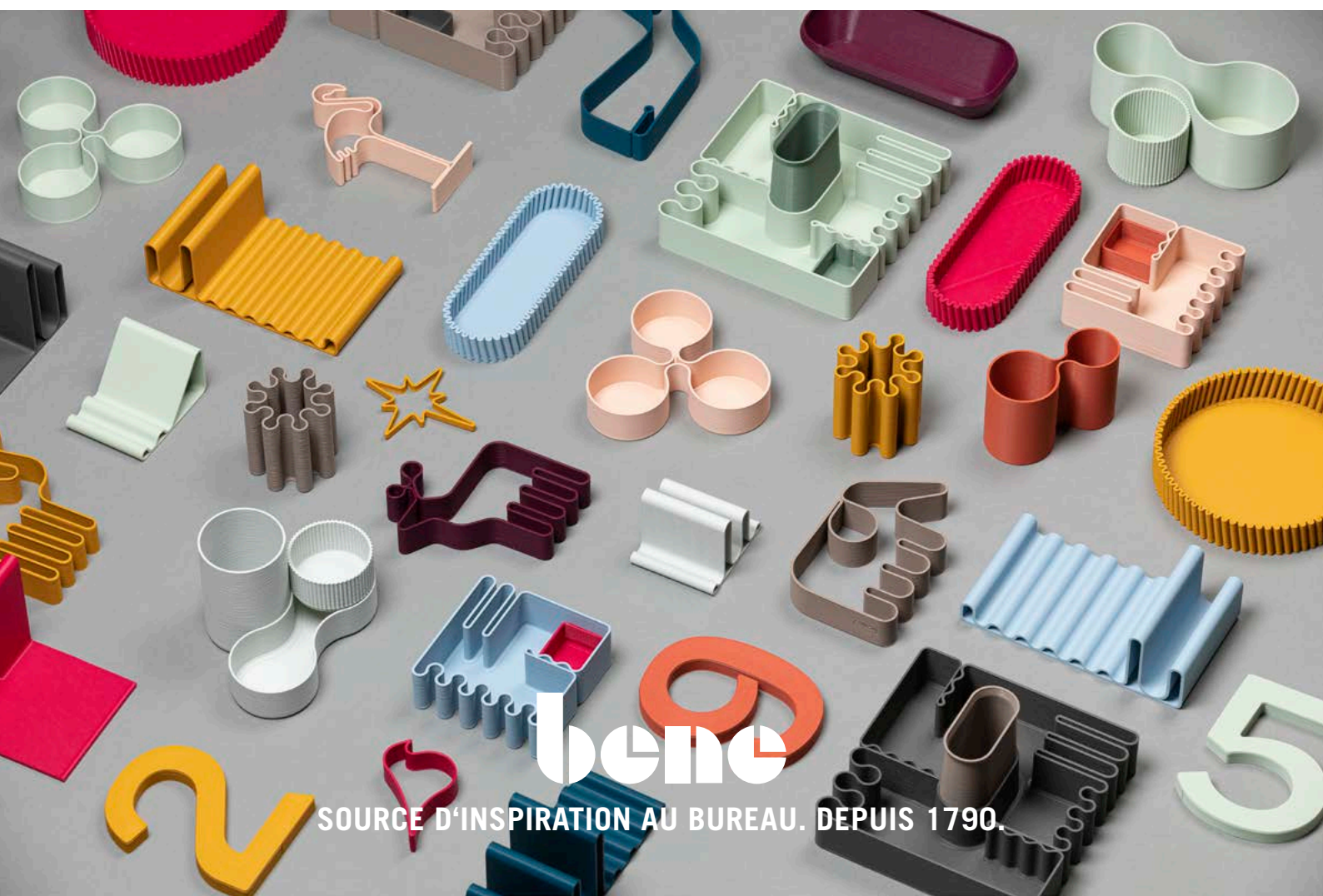

## DESCRIPTION DU PRODUIT ET DIMENSIONS

Collection d'accessoires imprimés en 3D en plastique biosourcé (PLA). Matière première fabriquée à partir de PLA recyclé mécaniquement, biodégradable et recyclable.

### REMARQUES

- Le PLA devient souple et mou à des températures supérieures à 50 °C. Pour cette raison, les bFRIENDS ne conviennent pas au nettoyage en lave-vaisselle.
- Le processus d'impression 3D FDM crée des lignes à la surface des éléments. L'impression peut également provoquer des irrégularités dans la structure de la surface. Celles-ci ne constituent pas un motif de réclamation.

### ORGANISERS

Whiteboard Pot

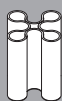

L: 76  
P: 76  
H: 82

Pen Pot

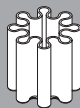

L: 82  
P: 82  
H: 82

Duo Pot

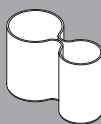

L: 64  
P: 128  
H: 82

Trio Pot

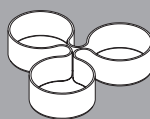

L: 165  
P: 152  
H: 35

Pen Tray

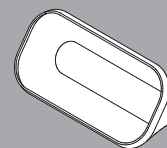

L: 100  
P: 210  
H: 51

Desk Pots



L: 130  
P: 177  
H: 109

Coin Bank



L: 119  
P: 119  
H: 99

Coin Collector



L: 32  
P: 175  
H: 60

Tilted Set

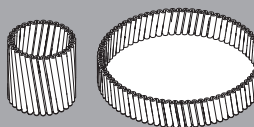

L: 80 / 195  
P: 80 / 195  
H: 82 / 35

Tilted Tray

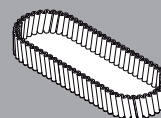

L: 80  
P: 220  
H: 32

Tray S

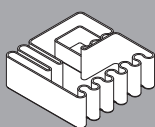

L: 128  
P: 128  
H: 45

Tray M

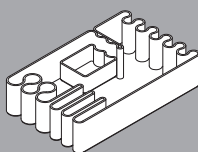

L: 128  
P: 205  
H: 45

Tray L

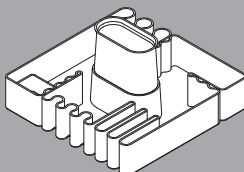

L: 205  
P: 205  
H: 105

Tidy Box

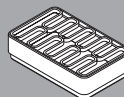

L: 66  
P: 105  
H: 28

Cable Box



L: 80  
P: 80  
H: 28

Stand XS

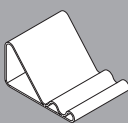

L: 82  
P: 105  
H: 57

Stand S

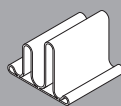

L: 82  
P: 92  
H: 69

Stand M

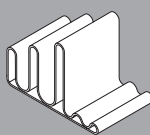

L: 82  
P: 137  
H: 91

Stand L

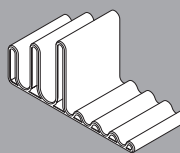

L: 82  
P: 189  
H: 91

Stand XL

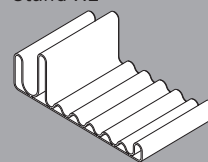

L: 120  
P: 211  
H: 69

Dimensions en mm

Bookend

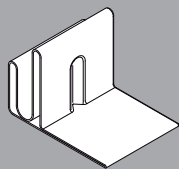

L: 120  
P: 161  
H: 111

**HANGERS, HOOKS & CLIPS**

Screen Hook 19

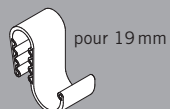

L: 45  
P: 76  
H: 85

Screen Hook 38

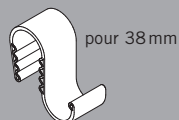

L: 45  
P: 91  
H: 93

Screen Hook 50

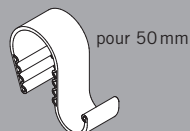

L: 45  
P: 102  
H: 110

Screen Clip 19



L: 45  
P: 47  
H: 68

Screen Clip 38



L: 45  
P: 60  
H: 72

Table Hook 13



L: 45  
P: 68  
H: 65

Table Hook 16



L: 45  
P: 69  
H: 67

Table Hook 19



L: 45  
P: 69  
H: 71

Table Hook 25



L: 45  
P: 71  
H: 77

Pizza Clip



L: 30  
P: 37  
H: 54

Coat Stand

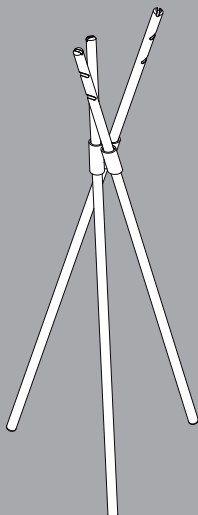

L: 575  
P: 556  
H: 1.691

Wall Hooks

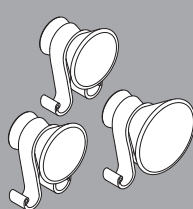

L: 80 / 100  
P: 72 / 86  
H: 124 / 134

Dimensions en mm

**DECORATION**

Wildlife Collection



Crocodile  
L: 33  
P: 186  
H: 49

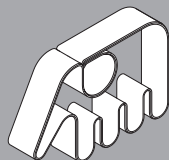

Elephant  
L: 33  
P: 170  
H: 110



Bird  
L: 20  
P: 86  
H: 45



Giraffe  
L: 33  
P: 117  
H: 199

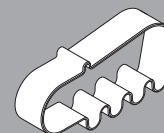

Hippo  
L: 33  
P: 162  
H: 76

Aquatic Collection



Penguin  
L: 33  
P: 67  
H: 123

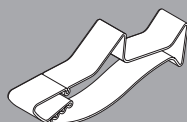

Shark  
L: 33  
P: 197  
H: 71

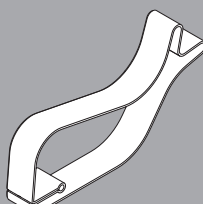

Whale  
L: 33  
P: 221  
H: 119



Seal  
L: 33  
P: 156  
H: 103



Fish  
L: 20  
P: 71  
H: 54

The Town Musicians

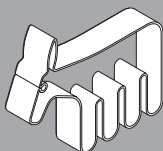

Donkey  
L: 33  
P: 176  
H: 152

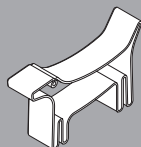

Dog  
L: 33  
P: 146  
H: 90



Cat  
L: 33  
P: 97  
H: 110



Rooster  
L: 20  
P: 60  
H: 59

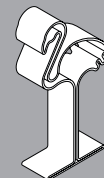

Flamingo / Flamingo Big  
L: 33 / 48  
P: 60 / 239  
H: 169 / 450

Desert Collection

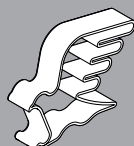

Falcon  
L: 22  
P: 110  
H: 81

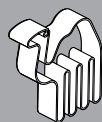

Camel  
L: 33  
P: 134  
H: 148

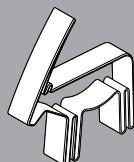

Oryx  
L: 33  
P: 173  
H: 199



Love Birds  
L: 22  
P: 90  
H: 68

Dimensions en mm

Xmas Collection

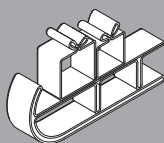

Sleigh with presents  
L: 33 / 33 / 33  
P: 190 / 50 / 40  
H: 82 / 66 / 56

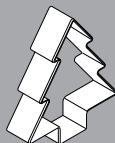

Xmas Tree  
L: 33  
P: 127  
H: 147



Star  
L: 33  
P: 92  
H: 90

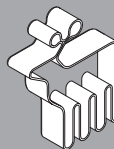

Reindeer  
L: 33  
P: 134  
H: 156



Snowman  
L: 33  
P: 85  
H: 140

Xmas Ornaments



Snowflake  
L: 8  
P: 94  
H: 107



Candy Cane  
L: 8  
P: 44  
H: 125



Stocking  
L: 8  
P: 63  
H: 108



Present  
L: 8  
P: 63  
H: 90



Bell  
L: 8  
P: 85  
H: 88



Ornament Star  
L: 8  
P: 102  
H: 120

Number 0

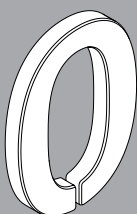

L: 15  
P: 120  
H: 160

Number 1

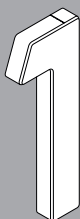

L: 15  
P: 57  
H: 160

Number 2



L: 15  
P: 115  
H: 160

Number 3



L: 15  
P: 123  
H: 160

Number 4



L: 15  
P: 108  
H: 160

Number 5



L: 15  
P: 124  
H: 160

Number 6



L: 15  
P: 119  
H: 160

Number 7

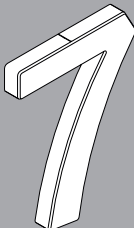

L: 15  
P: 120  
H: 160

Number 8



L: 15  
P: 126  
H: 160

Number 9



L: 15  
P: 119  
H: 160

Dimensions en mm

**VASES & PLANT POTS**

Vases 3

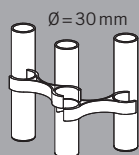

L: 38  
P: 166  
H: 150

Vases 5

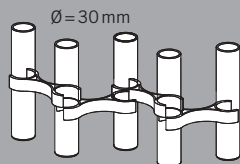

L: 38  
P: 296  
H: 150

Big Vases 3

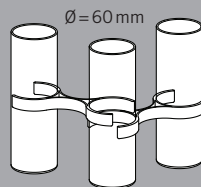

L: 65  
P: 278  
H: 185

Vases Mix 5

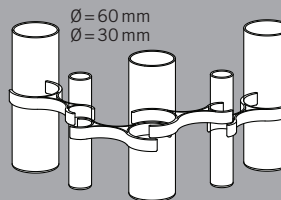

L: 65  
P: 420  
H: 185

Plant Pots  
Plant Pots

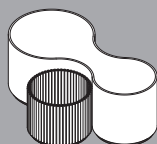

L: 143  
P: 207  
H: 73

Plant Pots L

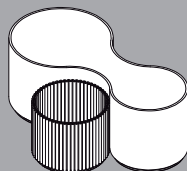

L: 182  
P: 275  
H: 98

Tilted Plant Pot L



L: 200  
P: 200  
H: 172

Dimensions en mm

## EXEMPLES D'UTILISATION

### ORGANISERS

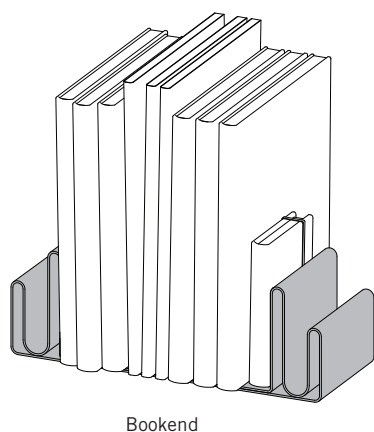
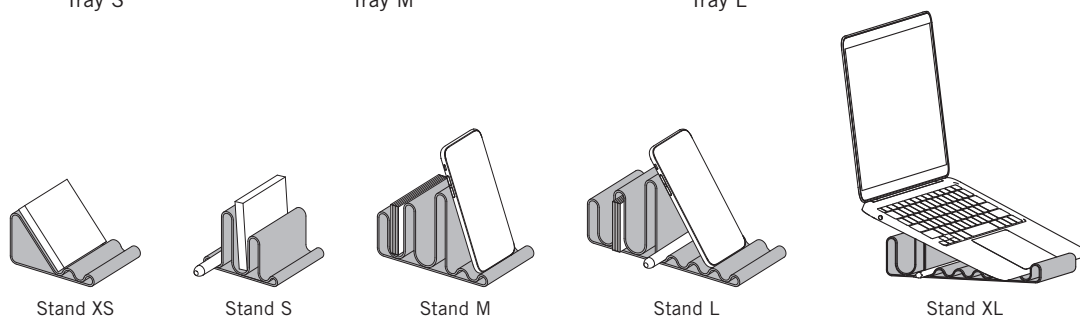
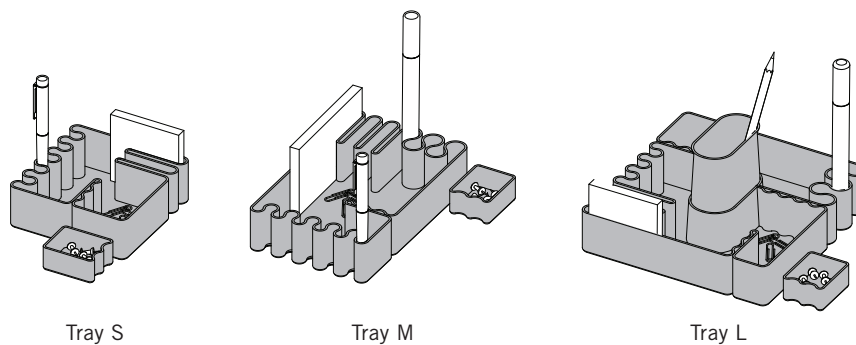
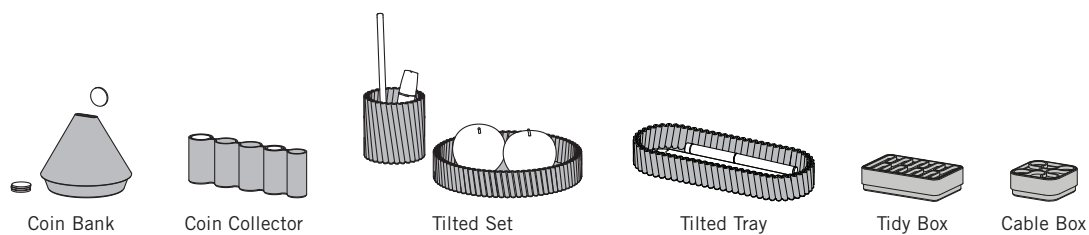
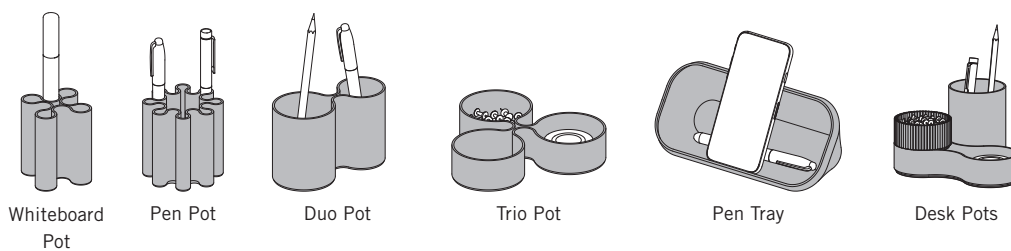

## EXEMPLES D'UTILISATION

### HANGERS, HOOKS & CLIPS

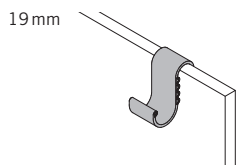

Screen Hook 19

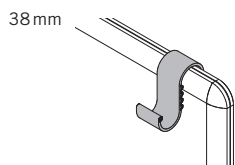

Screen Hook 38

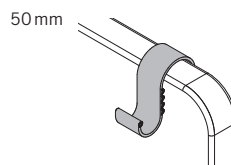

Screen Hook 50

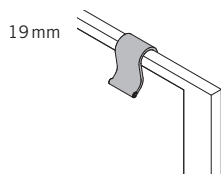

Screen Clip 19

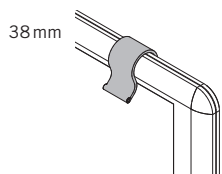

Screen Clip 38

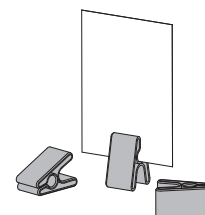

Pizza Clip

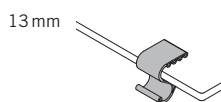

Table Hook 13

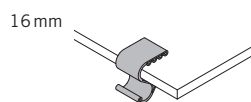

Table Hook 16

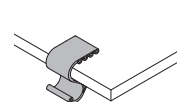

Table Hook 19

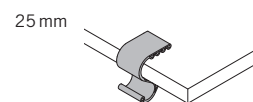
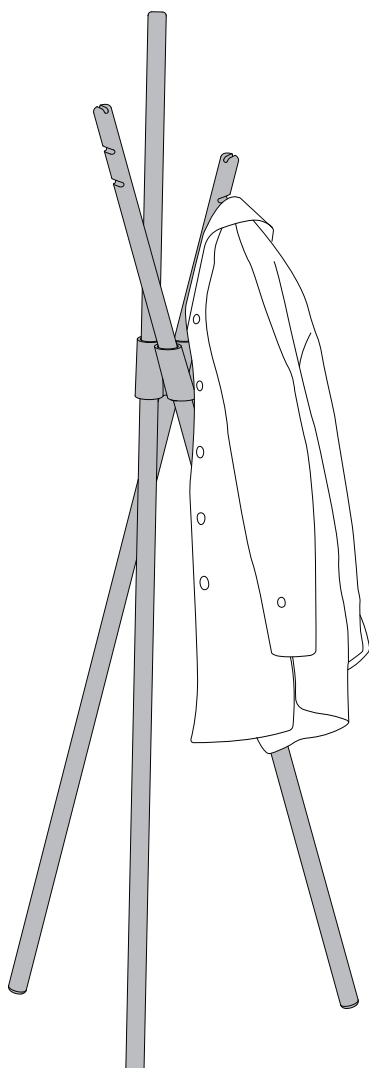
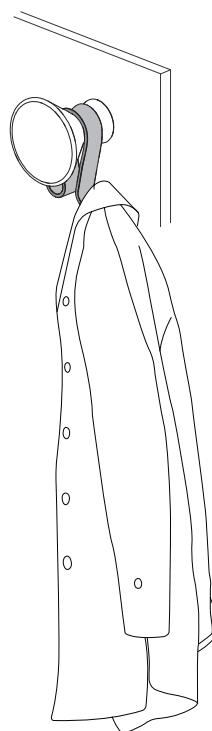

Table Hook 25



Coat Stand



Wall Hook



## EXEMPLES D'UTILISATION

### DECORATION

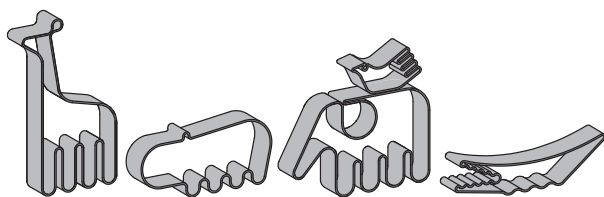

Wildlife Collection

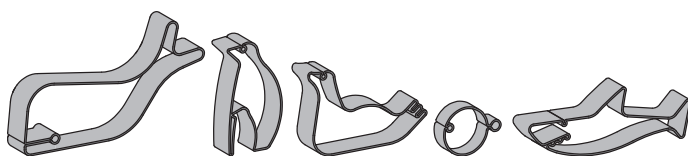

Aquatic Collection

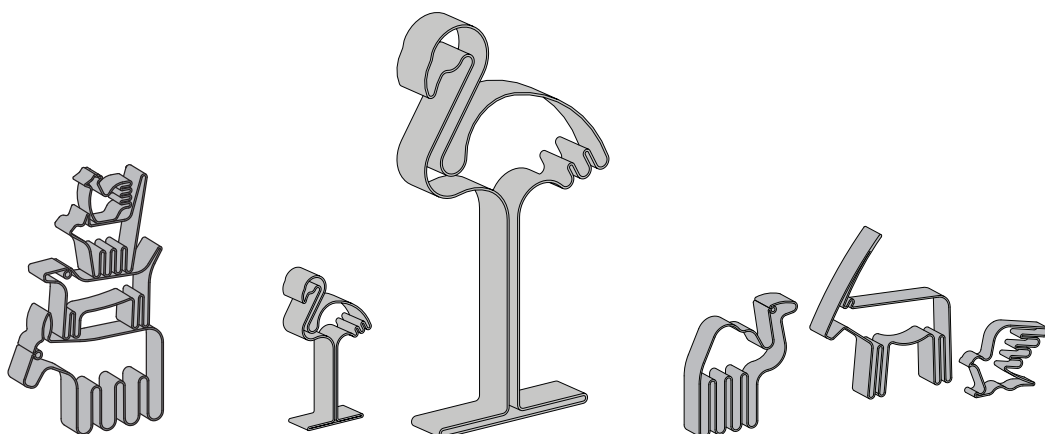

The Town Musicians

Flamingo + Flamingo Big

Desert Collection

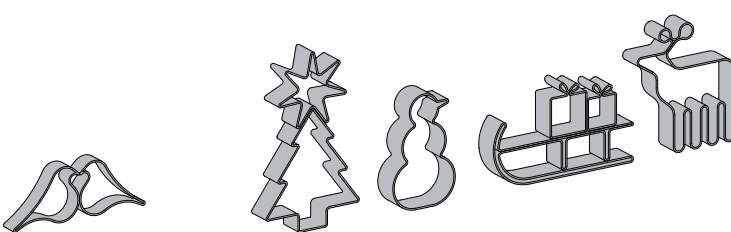

Love Birds

Xmas Collection

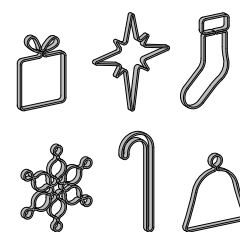

Xmas Ornaments

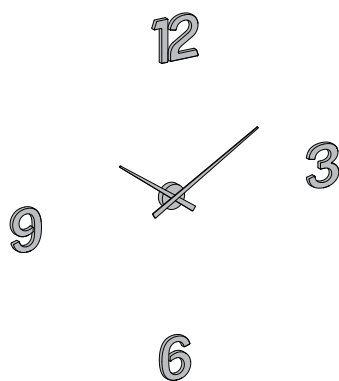

Wall Clock Set 3-6-9-12

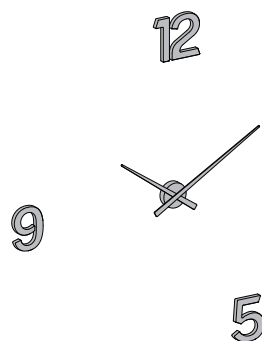

Wall Clock Set 5-9-12

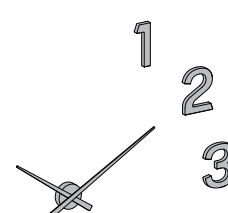

Wall Clock Set 1-2-3

## EXEMPLES D'UTILISATION

### VASES & PLANT POTS

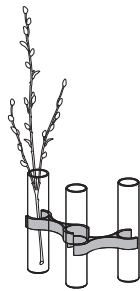

Vases 3

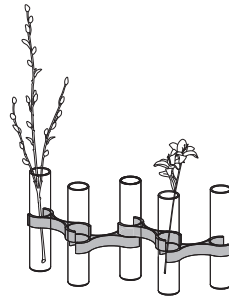

Vases 5

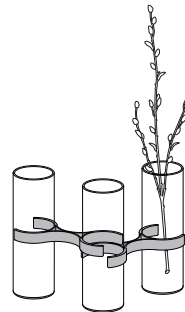

Big Vases 3

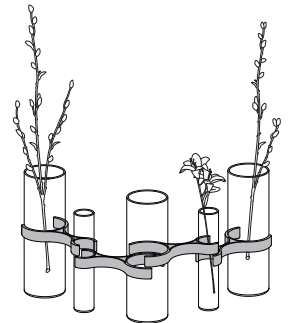

Vases Mix 5

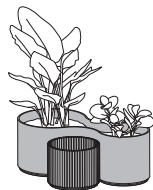

Plant Pots

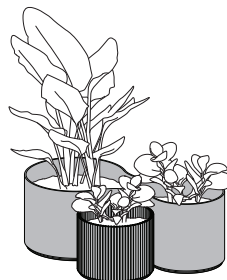

Plant Pots L

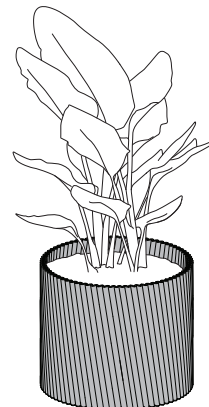

Tilted Plant Pot L

## CONFIGURATION DES COULEURS

Les accessoires bFRIENDS suivants sont disponibles dans des couleurs ou des combinaisons de couleurs prédéfinies.

### ORGANISERS

#### Coin Bank

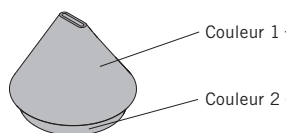

#### Tidy Box

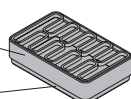

#### Cable Box

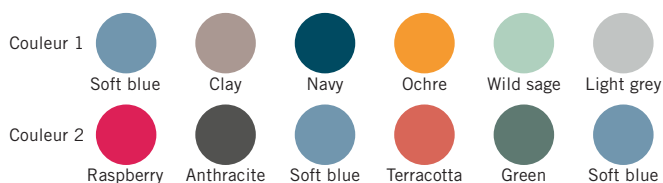
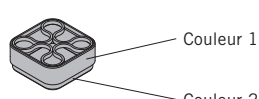

#### Tray S, M et L

Les plateaux sont dotés d'un Pin Pot pour les petits accessoires, le Tray L possédant en plus une partie centrale pour déposer des objets.

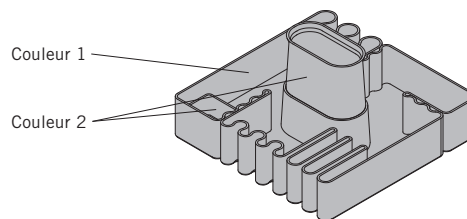
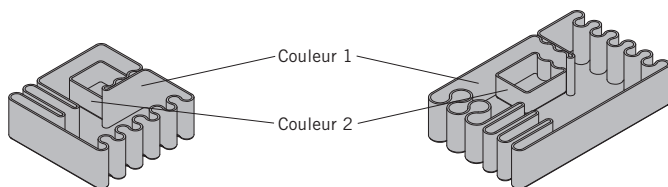

## CONFIGURATION DES COULEURS

### DECORATION

Toutes les pièces des collections présentées sont vendues en set ou individuellement. Chaque set se compose de couleurs prédéfinies, comme illustré ci-après. Si les éléments décoratifs sont commandés séparément, ils sont disponibles dans toutes les couleurs de la collection standard bFRIENDS.

#### Wildlife Collection

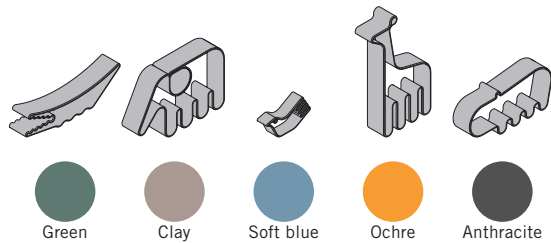

#### Aquatic Collection

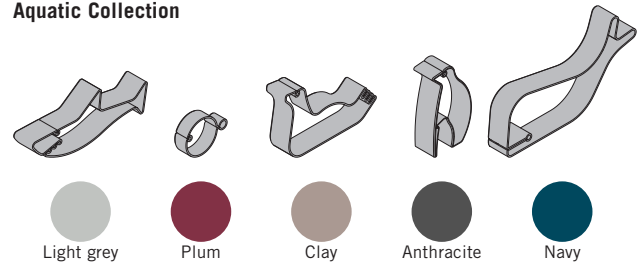

#### The Town Musicians

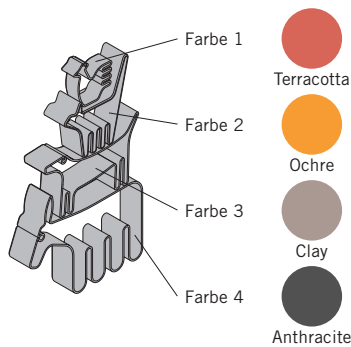

#### Desert Collection

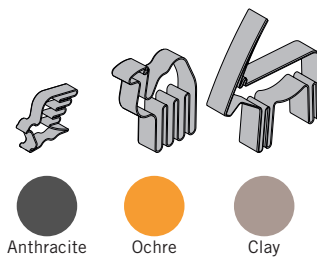

#### Love Birds

Un set se compose de deux Love Birds. Ceux-ci sont disponibles au choix dans la même couleur ou dans deux couleurs différentes prédéfinies.

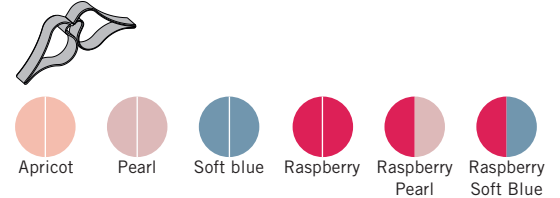

#### Xmas Collection

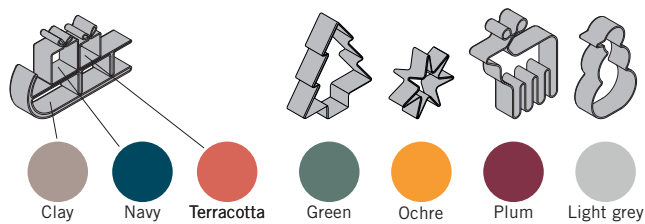

#### Xmas Ornaments

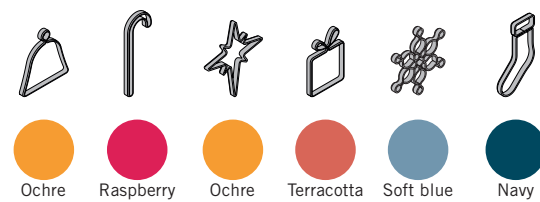

#### Wall Clocks

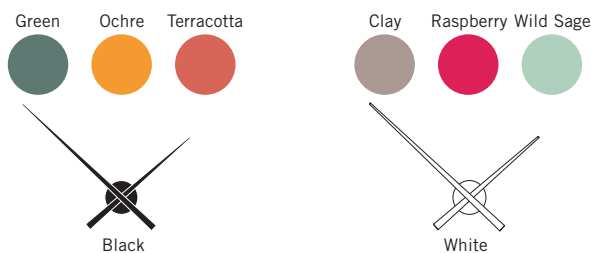

Le mouvement d'horlogerie existe au choix en Black ou en White, avec trois couleurs assorties prédéfinies pour les chiffres. Ces derniers sont également proposés dans toutes les couleurs de la collection standard bFRIENDS en option.

## DESCRIPTION DU PRODUIT BFRIENDS POWER MODULE

Le bFRIENDS Power Module est disponible en trois tailles - S, M et L.

Il peut être monté sur toutes les tables, partout où une sortie de câble est possible. Il est également possible de remplacer un Power Module à un trou de sortie de câble existant (diamètre 80 mm; jusqu'à une épaisseur de panneau de 25 mm). Pas possible en combinaison avec un plateau coulissant ou top-access.

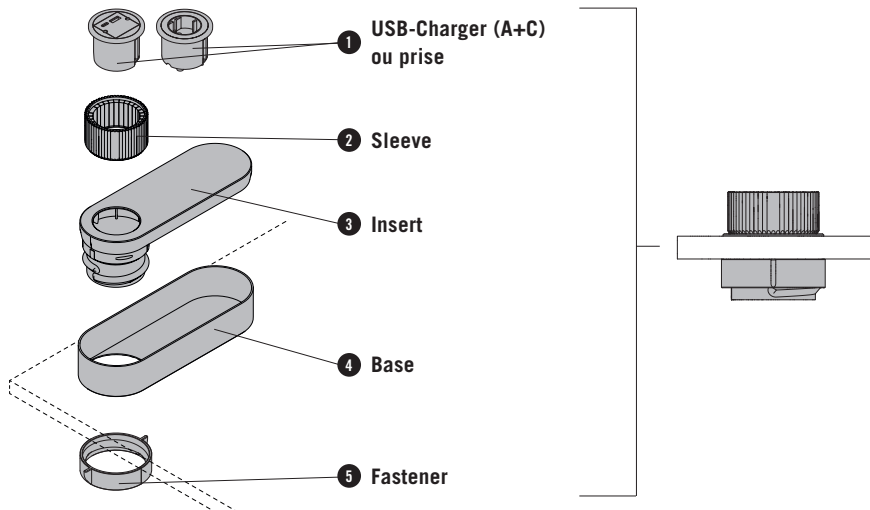

### TYPES DE BFRIENDS POWER MODULE

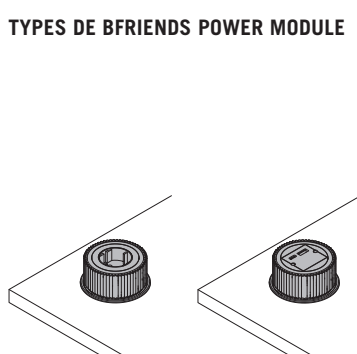

**Type S**  
avec prise ou USB-Charger (A+C)  
prises de recharge USB-A 18W / USB-C 22W

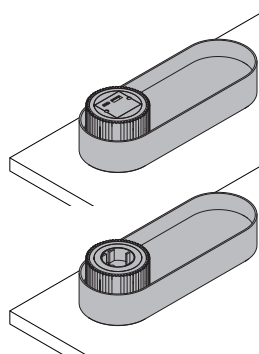

**Type M**  
avec prise ou USB-Charger (A+C)  
prises de recharge USB-A 18W / USB-C 22W

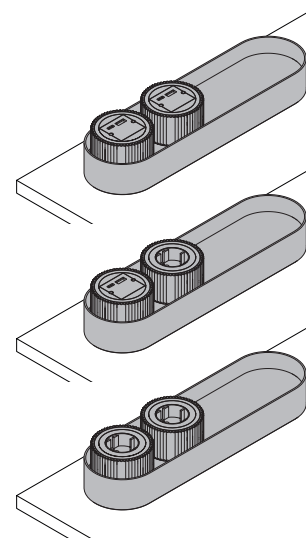

**Type L**  
avec prise et/ou USB-Charger (A+C)  
prises de recharge USB-A 18W / USB-C 22W  
(disponible: 2 x prises | 2 x USB |  
1 x prise + 1 x USB)

## DIMENSIONS BFRIENDS POWER MODULE

BFRIENDS POWER MODULES		
bFRIENDS Power Module S	bFRIENDS Power Module M	bFRIENDS Power Module L
L: 86 P: 86 H: 36/87	L: 268 P: 92 H: 67/118	L: 348 P: 92 H: 67/118
<b>Dimensions en mm</b>		

## CONFIGURATION DES COULEURS

### BFRIENDS POWER MODULE S, M ET L

Les bFRIENDS Power Modules sont disponibles dans les couleurs présentées ci-dessous. La couleur 1 et la couleur 2 peuvent être combinées à volonté dans la même couleur ou dans des couleurs différentes. Le Fastener est toujours en Anthracite.

#### Type S

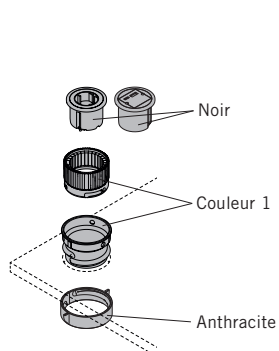

#### Type M

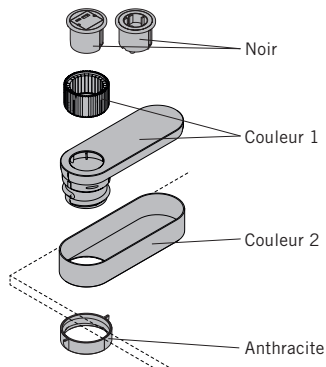

#### Type L

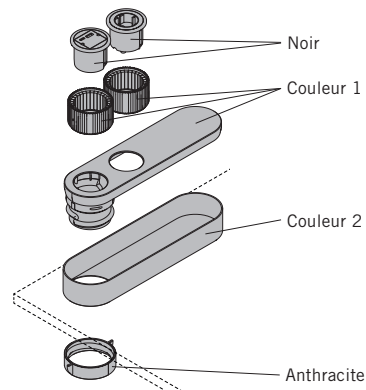

#### Information sur la livraison

Les combinaisons de couleurs suivantes sont en stock et disponibles à court terme :

bFRIENDS Power Module S: Anthracite  
Green

bFRIENDS Power Module M+L: Couleur 1 Anthracite + Couleur 2 Light Grey  
Couleur 1 Anthracite + Couleur 2 Green

Toutes les autres variantes de couleurs nécessitent un délai de livraison plus long.

#### Câblage

Il est nécessaire de configurer un câble branchement initial ou un câble connectique de la longueur requise.

## COULEURS & MATERIAUX



Clay



Light grey



Wild sage



Green



Anthracite



Apricot



Pearl



Soft blue



Navy



Ochre



Terracotta



Plum



Raspberry



Vibrant Yellow <sup>1</sup>



Light Orange <sup>1</sup>



Pink <sup>1</sup>

<sup>1</sup> Edition limitée exclusivement pour Flamingo et Flamingo Big, dans la limite des stocks disponibles

### BOIS (FRÊNE)

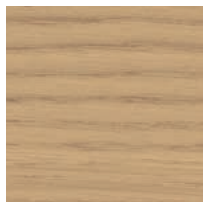

Natural



Vulcano

### PLASTIQUE

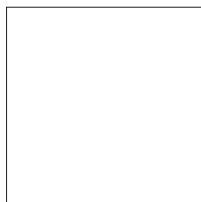

White



Black

### VERRE

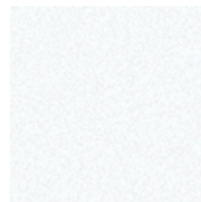

Clear glass

# EMBALLAGE

Sureballage (dimensions en mm)

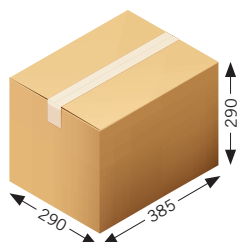

Image: Emballage individuel

Quantité minimale de commande : 10

Quant. min. de commande : 5

## Dimension A



Tidy Box



Cable Box



Table Hook 13



Table Hook 16



Table Hook 19



Table Hook 25

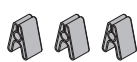

Pizza Clip



Bird



Fish



Rooster



Love Birds

## Dimension B



Snowman

## Dimension C



Stand XS



Stand S

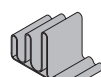

Stand M



Whiteboard Pot



Pen Pot



Duo Pot



Crocodile



Hippo



Penguin



Seal



Dog



Cat



Tilted Pot



Falcon



Star



Xmas Ornaments Collection



Snowflake



Candy Cane



Stocking



Present



Present



Bell



Bell



Ornament Star

## Dimension D



Camel



Tilted Tray



Xmas Tree



Sleigh with presents



Reindeer

## Dimension E

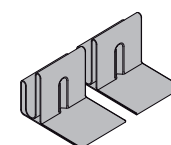
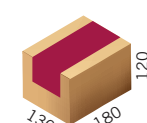

Bookend Set

Sous réserves de modifications!



# EMBALLAGE

Sureemballage (dimensions en mm)

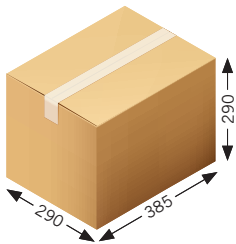
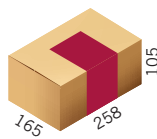

Image: Emballage individuel

Quantité minimale de commande : 5

Quantité minimale de commande : 1

## Dimension F



- Stand L
- Elephant
- Tray M
- Xmas Collection
- Stand XL
- Giraffe
- Vases 3
- Vases Mix 5
- Trio Pot
- Shark
- Vases 5
- Whale
- Plant Pots
- Pen Tray
- Donkey
- Aquatic Collection
- Desk Pots
- Flamingo
- Wildlife Collection
- Coin Bank
- Oryx
- Coin Collector
- Desert Collection
- Tray S
- The Town Musicians

## Dimension G

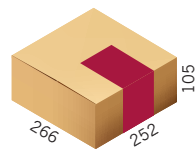

- Tilted Set
- Big Vases 3
- Tray L
- Plant Pots L
- Tilted Bowl

## Dimension I

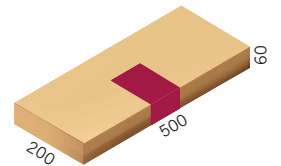

## Dimension J

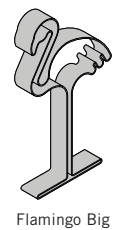
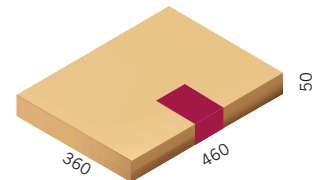

## Dimension H

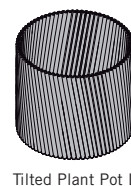
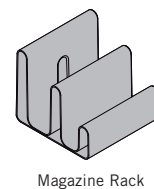
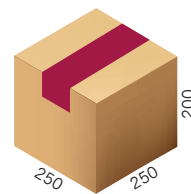

## Dimension K

LxPxH: 1.344x104x99 mm

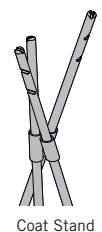

Sous réserves de modifications!

## LA RESPONSABILITÉ SOCIALE CHEZ BENE

Bene joue un rôle de précurseur dans le domaine du développement durable. Tous les secteurs de l'entreprise sont concernés : du développement au recyclage des produits en passant par les achats, la production et la logistique. Les exigences écologiques sont systématiquement intégrées dans le processus de développement des produits, de la première ébauche à la production en série. Elles incluent le choix de matériaux propres comme les bois certifiés provenant de forêts gérées durablement, le recours à des matériaux recyclés ou encore l'utilisation accrue de matières premières renouvelables. Labellisation des matériaux, facilité de réparation et longue durée de vie des composants utilisés sont également des éléments essentiels dans la conception de nos produits, ce qui permet de leur offrir un deuxième cycle de vie. Pour garantir une capacité de recyclage élevée de nos produits en fin de vie, nous renonçons autant que faire se peut aux matériaux composites et produisons un mobilier démontable facilitant le tri des matières.

99,9 % de nos livraisons proviennent d'un pays européen. Près de 94 % des livraisons de matières premières proviennent d'Autriche et d'Allemagne. Environ 93 % des matières premières sont livrées par des fournisseurs situés dans un rayon de 500 km autour de notre site de production.

### DES MATIERES PREMIERES DURABLES

Pour Bene, l'utilisation des éléments suivants relève de l'évidence :

- panneaux de particules fines à faible teneur en formaldéhyde,
- colles à faible teneur en formaldéhyde,
- laques à l'eau,
- matières recyclables,
- matériaux ayant un taux de recyclage élevé,
- matières plastiques sans PVC.

Bene garantit que ses produits sont sans :

- substances CMR,
- solvants halogénés dans les matières plastiques,
- hydrocarbures chlorés,
- pigments de métaux lourds,
- matériaux contenant des colorants azoïques,
- revêtements à effet biocide (ex. : traitements conservateurs du bois, pesticides).

### CONTRIBUTION A LA CERTIFICATION DES BATIMENTS

Dans le cadre de la certification écologique des bâtiments, les systèmes d'aménagement tels que le mobilier ou les cloisons jouent un rôle non négligeable pour parvenir à un meilleur résultat, c'est-à-dire obtenir plus de points.

Les produits de Bene apportent leur contribution aux normes LEED, WELL Building Standard, DGNB, BREEAM, etc. Parmi les critères permettant d'obtenir ces certifications figurent, par exemple, les déclarations environnementales de produits, la qualité de l'air intérieur, l'acoustique ou encore la capacité de réaffectation/changement d'utilisation du bâtiment.

---

### BFRIENDS

#### Exemple de configuration

- Tray S
- poids total : 0,12 kg

#### Indicateurs environnementaux

- Tri par type de matériau possible à 100 %
- 100 % de composants recyclables
- 100 % de matières premières renouvelables
- 98,5 % de matériaux de production recyclés

#### Matériaux

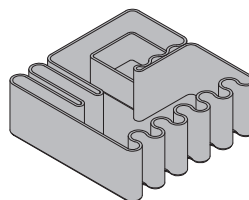
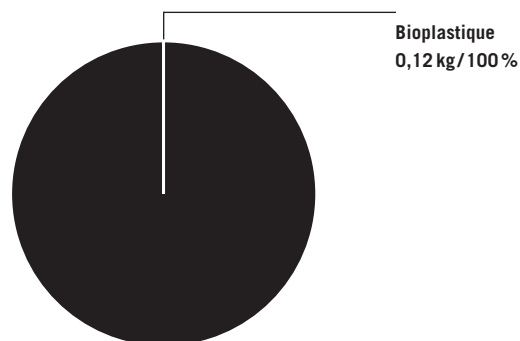

Pour toute configuration de produit standard, des déclarations environnementales de produits (DEP, ACV) peuvent être fournies sur simple demande. Il s'agit de fiches techniques d'évaluation du cycle de vie, appelées LCDS (pour « Life Cycle Data Sheets ») chez Bene.

Vous trouverez la liste des certificats de produits ainsi que des récompenses/prix de design obtenus sur le site Internet de Bene.

Informations environnementales de Bene : <https://bene.com/en/sustainability-report-2021/>